



Indoor & Outdoor Lighting

Ram Ratna International | KABRA GLOBAL (RR Global Company)

Ram Ratna House, Oasis Complex, P. B. Marg, Worli, Mumbai - 400 013, India.
T : +91-022-2494 9009 / 2492 4144 • F : +91-22-2493 0203 / 2493 2339

RR ELECTRICAL Middle East FZC
Member - RR Global

Regd. Office :
Q4 - 016, 017 & 018, Saif Zone, P. O. Box: 8325, Sharjah, United Arab Emirates.
T : +9716 - 5529 747 • F : +9716 - 5529 537 • E : relectrical@ramratna.net

www.rr-world.co.in

CC0116RRL.COM/22PGRRIE





Innovation, transparency and trust are the key drivers to growth and excellence in RR Global. In fact, it is a way of life. Present in over 73 countries across the globe, the group endeavors to set standards that redefine quality, delivery and customer care. The Group's success is attributed to its promptness in identifying and responding to emerging market needs. Top-of-the-line technologies driven by a skilled team of technocrats give the Group a cutting edge in both domestic and global markets.

In line, with our Group's vision, we are proud to bring to you a comprehensive range of lighting products, both indoor and outdoor range. The range offers a sleek and modern design which comes with the best in class quality, safety and reliability that have been the hallmark of our group over the years.

INDEX

PARTICULARS	PAGE NO.
Modular Luminaries	1-2
Battens	3-4
Fluorescent Battens	
Prismatic / Acrylic Grill Fluorescent Batten	
Weather Proof Battens	5-6
High Bay & Flood Light	7-10
Up and Down & Wall Lights	11-12
Globe Series	13-14
Bulkhead	15-16
Ballast & Accessories	17-18
Magnetic Ballast	
Electronic Ballast	
Metal Halide & Sodium Ballast	
Emergency Kit	
Ignitors	
Capacitors	
Fluorescent Tubes & Lamps	19-21
Emergency Lighting	22-25
Fluorescent Emergency	
Led Emergency	
Exit Lights	

MODULAR LUMINARIES

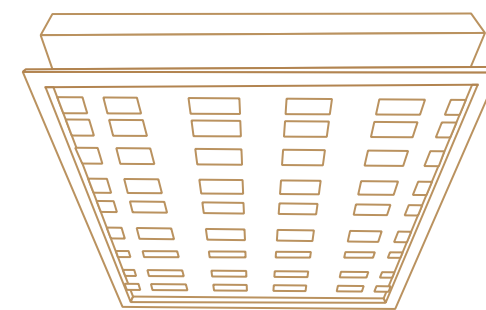

CAT No.	DESCRIPTION
RR-RM418	4x18 Recessed Modular Luminaires Fluorescent with Magnetic Ballast
RR-RM418ED	4x18 Recessed Modular Luminaires Fluorescent with Magnetic Ballast - DAMPA
RR-RM418EFF	4x18 Recessed Modular Luminaires with Flat Edge Fluorescent with Magnetic Ballast - Prismatic DAMPA
RR-SM418	4x18 Surface Mounted Modular Luminaires Fluorescent with Magnetic Ballast
RR-RM236	2x36 Recessed Modular Luminaires Fluorescent with Magnetic Ballast
RR-RM236EFF	2x36 Recessed Modular Luminaires with Flat Edge Fluorescent with Magnetic Ballast
RR-SM236	2x36 Surface Mounted Modular Luminaires Fluorescent with Magnetic Ballast
RR-RM436	4x36 Recessed Modular Luminaires Fluorescent with Magnetic Ballast
RR-SM436	4x36 Surface Mounted Modular Luminaires Fluorescent with Magnetic Ballast
RR-SM418CV	4x18 Surface Mounted Round Type Modular Luminaires with Electronic Ballast, 220-240v 50/60Hz
RR-SM236CV	2x36 Surface Mounted Round Type Modular Luminaires with Electronic Ballast, 220-240v 50/60Hz



CAT No.	DESCRIPTION
RR-RM418P	4x18 Recessed Prismatic Modular Luminaires Fluorescent with Magnetic Ballast
RR-RM236P	2x36 Recessed Prismatic Modular Luminaires Fluorescent with Magnetic Ballast
RR-RM418EDP	4x18 Recessed Modular Luminaires Fluorescent with Magnetic Ballast - Prismatic DAMPA



CAT No.	DESCRIPTION
RR-RM414	4x14 T5 Modular Luminaires Fluorescent with Electronic Ballast

* Suitable for 220-240V 50Hz. * For 60Hz Add Suffix 220V 60Hz to Catalog No. * Can be supplied with electronic ballast. Add Suffix HF to Catalog No.

BATTEN

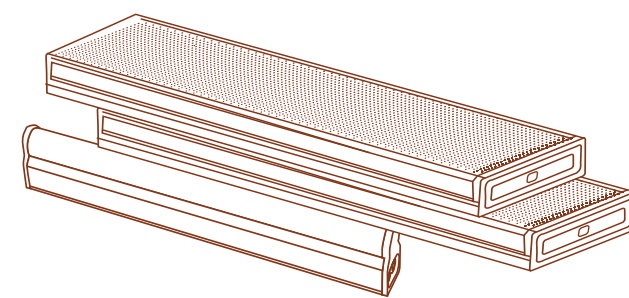

FLUORESCENT T8 BATTEN



CAT No.	DESCRIPTION
RR-B118	1x18W Fluorescent Batten with Magnetic Ballast 220-240v 50Hz
RR-B218	2x18W Fluorescent Batten with Magnetic Ballast 220-240v 50Hz
RR-B136	1x36W Fluorescent Batten with Magnetic Ballast 220-240v 50Hz
RR-B236	2x36W Fluorescent Batten with Magnetic Ballast 220-240v 50Hz
RR-B158	1x58W Fluorescent Batten with Magnetic Ballast 220-240v 50Hz
RR-B258	2x58W Fluorescent Batten with Magnetic Ballast 220-240v 50Hz

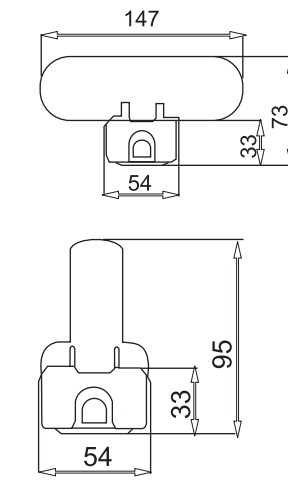

PRISMATIC / ACRYLIC GRILL FLUORESCENT BATTEN



CAT No.	DESCRIPTION
RR-DB118	1x18W Diamond Diffuser Batten with Magnetic Ballast 220-240v 50Hz
RR-DB218	2x18W Diamond Diffuser Batten with Magnetic Ballast 220-240v 50Hz
RR-DB136	1x36W Diamond Diffuser Batten with Magnetic Ballast 220-240v 50Hz
RR-DB236	2x36W Diamond Diffuser Batten with Magnetic Ballast 220-240v 50Hz

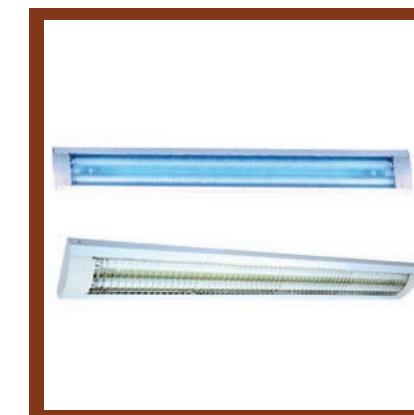
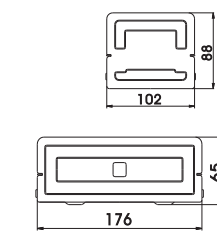

RR-BAC6218	2x18 Batten With Acrylic Cover and Grill Fitted with Cooper Magnetic Ballast 220-240v 50Hz
RR-BAC6236	2x36 Batten With Acrylic Cover and Grill Fitted with Cooper Magnetic Ballast 220-240v 50Hz
RR-BG218	2x18 Batten With Grill Fitted with Cooper Magnetic Ballast 220-240v 50Hz
RR-BG236	2x36 Batten With Grill Fitted with Cooper Magnetic Ballast 220-240v 50Hz

* Suitable for 220-240V 50Hz. * For 60Hz Add Suffix 220V 60Hz to Catalog No. * Can be supplied with electronic ballast. Add Suffix HF to Catalog No.

WEATHER PROOF BATTEN

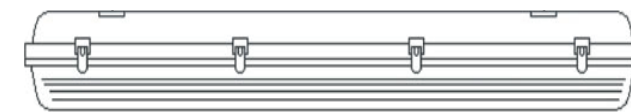

CAT No.	DESCRIPTION
RR-WP118	1x18W Weather Proof Fluorescent Batten IP-65 with Magnetic Ballast
RR-WP218	2x18W Weather Proof Fluorescent Batten IP-65 with Magnetic Ballast
RR-WP136	1x36W Weather Proof Fluorescent Batten IP-65 with Magnetic Ballast
RR-WP236	2x36W Weather Proof Fluorescent Batten IP-65 with Magnetic Ballast
RR-WP158	1x58W Weather Proof Fluorescent Batten IP-65 with Magnetic Ballast
RR-WP258	2x58W Weather Proof Fluorescent Batten IP-65 with Magnetic Ballast
RR-WP T5 118	1x28W T5 Weather Proof Fluorescent Batten IP-65 with Electronic Ballast
RR-WP T5 228	2x28W T5 Weather Proof Fluorescent Batten IP-65 with Electronic Ballast

Luminaire Details:

Housing:
 [Option] Thermal resistant poly carbonate, PC / PC
 [Option] Glass reinforced body

Reflector:
 White polyester powder coated steel sheet

Optics:
 Poly carbonate

Wiring:
 Internal Wiring - PVC Insulated single conductor wire 105°C heat resistant heat resistant

Mounting:
 Surface Mounted
 Stainless Steel Clips are available on request

Installation diagram :

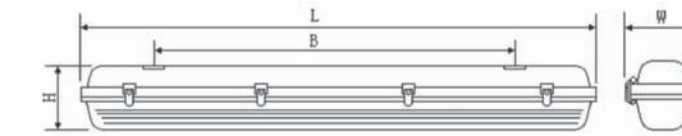

Accessories

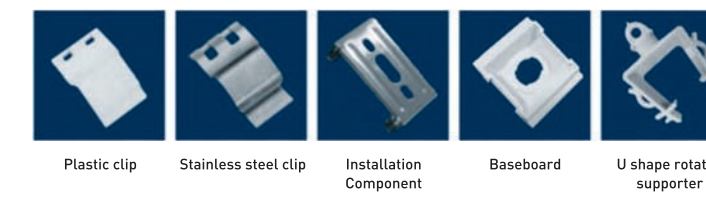

Lamp Details:

Lamp Base : TLD, TL5, Fluorescent Lamp / Triphosphor Lamp / LED versions available on request

Lamp Type
 G13 / G5

* Suitable for 220-240V 50Hz. * For 60Hz Add Suffix 220V 60Hz to Catalog No. * Can be supplied with electronic ballast. Add Suffix HF to Catalog No.

HIGH BAY & FLOOD LIGHT

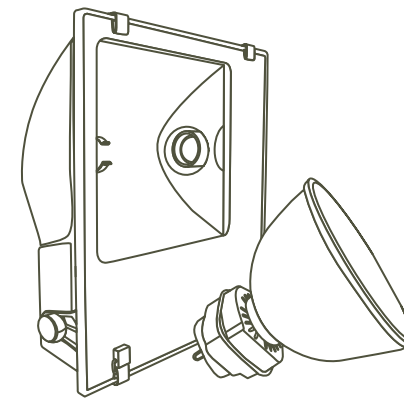

HIGH BAY



Luminaire Details:

Housing: Made of high pressure die cast aluminium body
 Reflector: 99.98% pure anodized spun aluminium
 Optics: Tempered Glass
 Wiring: Internal Wiring - PVC Insulated single conductor wire 105°C heat resistant heat resistant
 Mounting: Suspended

Lamp Details:

Lamp Type : Metal Halide / High Pressure Sodium Vapour (HPSV) / Mercury Vapour
 Lamp Base : E40 / E27

Control Gear / Transformer Detail:

Reference :Electromagnetic
 Voltage : 230V50Hz / 240V50Hz / 220-240V50/60Hz / 110V-240V50/60Hz
 Power Factor :HPF / Ingnator

Applications:

Warehouses
 Shopping Malls
 Industrial Areas
 Factories
 Aircraft Hangar and maintenance Bays

Part No.	Description
RRHB - 250 MH	250W MH High Bay Ip65
RRHB - 400 MH	400W MH High Bay IP65



* Suitable for 220-240V 50Hz. * For 60Hz Add Suffix 220V 60Hz to Catalog No.

Flood Light



Luminaire Details:

Housing:
Die cast aluminium body

Reflector:
Extra pure aluminium sheet, polished and oxidized

Optics:
Transparent protecting glass with silicon sealing gasket

Wiring:
Internal Wiring - PVC Insulated single conductor wire 105°C heat resistant heat resistant

Mounting:
On Ground

Dimension:
450x470x165 mm (MIDO 250W & 400W)
570x580x250 mm (MIDO PLUS 1000W)

Lamp Details:

Lamp Type : Metal Halide
Lamp Base : E40

Control Gear / Transformer Detail:

Reference : Electromagnetic
Voltage : 230V50Hz / 240V50Hz / 110V-240V50/60Hz
Power Factor : HPF

Optional Accessories:

Color (Customized)

Applications:

Sports Areas
General Floodlighting
Building Facades
Car Parks
Loading Bays
Security Lighting
Garden Lighting

Part No.	Description
RRFL-MD-250WIP65	250W Flood Light Body, Complete Fitted with Ballast, Capacitor & Ignitor
RRFL-MD-400WIP65	400W Flood Light Body, Complete Fitted with Ballast, Capacitor & Ignitor
RRFL-MDPL-1000MH	1000W Fixture complete with Ballast with Ignitor with Capacitor



Flood Light



Luminaire Details:

Housing:
Die cast aluminium body

Reflector:
Extra pure aluminium sheet, polished and oxidized

Optics:
Transparent protecting glass with silicon sealing gasket

Wiring:
Internal Wiring - PVC Insulated single conductor wire 105°C heat resistant heat resistant

Mounting:
On Ground

Lamp Details:

Lamp Type : Metal Halide
Lamp Base : E40 / R7S / E27

Control Gear / Transformer Detail:

Reference : Electromagnetic
Voltage : 230V50Hz / 240V50Hz / 110V-240V50/60Hz

Applications:

Sports Areas
General Floodlighting
Building Facades
Car Parks
Loading Bays
Security Lighting
Garden Lighting

Part No.	Description
RRFL-250WMHIP65	250 Watt MH Flood Light IP65
RRFL-400WMHIP65	400 Watt MH Flood Light IP65
RRFL-70MH07E27	70W Metal Halide Flood Light IP65 with E27 Lamp Holder
RRFL-70MH07R7S	70W Metal Halide Flood Light IP65 with R7S Lamp Holder
RRFL-150MH07E27	150W Metal Halide Flood Light IP65 with E27 Lamp Holder
RRFL-150MH07R7S	150W Metal Halide Flood Light IP65 with R7S Lamp Holder
RRFL-70WMHIP65	70 Watt MH Flood Light Ip65 with E27 Lamp Holder
RRFL-150WMHIP65	150 Watt MH Flood Light Ip65 with E27 Lamp Holder



UP AND DOWN & WALL LIGHTS

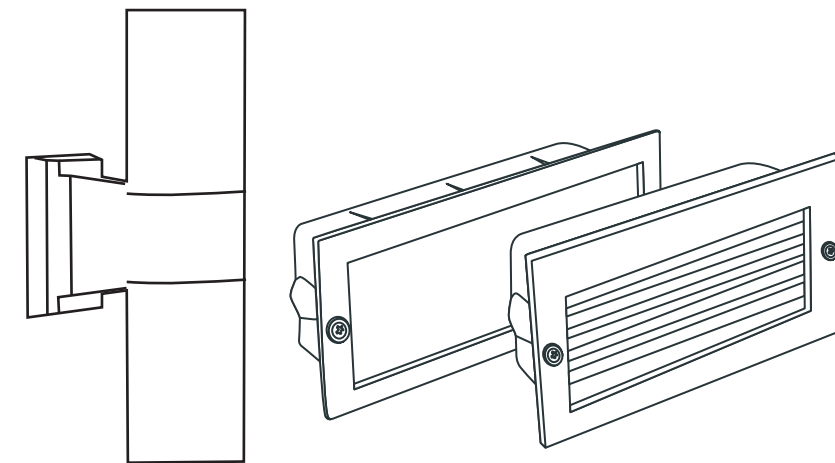

WALL LIGHTS



CAT No. DESCRIPTION

CAT No.	Power	Grade	Color	Lamp Holder
RR-WL09	60W	IP54	Black White	E27



CAT No. DESCRIPTION

CAT No.	Power	Grade	Color	Lamp Holder
RR-WL02	60W	IP54	Black White	E27

UP AND DOWN WALL LIGHTS

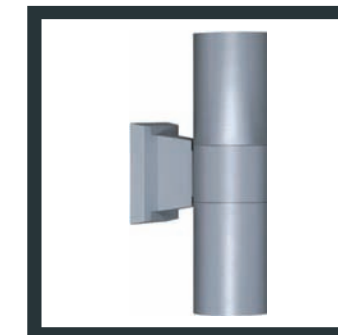

CAT No. DESCRIPTION

- RR-2007BK Up and Down Wall Lights with Gu10 Lamp Holders, Size : 65x160mm, Body Color : Black
- RR-2007SN Up and Down Wall Lights with Gu10 Lamp Holders, Size : 65x160mm, Body Color : Silver
- RR-2008BK Up and Down Wall Lights with Gu10 Lamp Holders, Size : 65x260mm, Body Color : Black
- RR-2008SN Up and Down Wall Lights with Gu10 Lamp Holders, Size : 65x260mm, Body Color : Silver

GLOBE SERIES

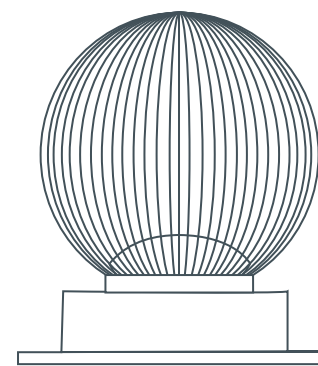

CAT No. DESCRIPTION

Size	Power	Grade	Color	Lamp Holder
6" (ø150mm)	15W	IP43	Trans- parent/ Tawny/ [Stripe]	E27
8" (ø200mm)	25W			
10" (ø250mm)	40W			
12" (ø300mm)	60W			
14" (ø350mm)	100W			
16" (ø400mm)	150W			

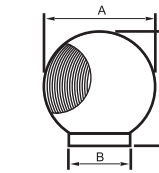

CAT No. DESCRIPTION

Size	Power	Grade	Color	Lamp Holder
6" (ø150mm)	15W	IP43	Opal/ Trans- parent/ Tawny/ [Glabrow]	E27
8" (ø200mm)	25W			
10" (ø250mm)	40W			
12" (ø300mm)	60W			
14" (ø350mm)	100W			
16" (ø400mm)	150W			
20" (ø400mm)	200W			

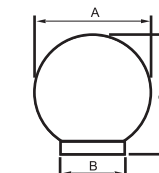

CAT No. DESCRIPTION

Size	Power	Grade	Color	Lamp Holder
6" (ø150mm)	15W	IP43	Trans- parent/ Tawny/ [Stripe]	E27
8" (ø200mm)	25W			

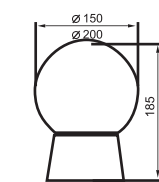

CAT No. DESCRIPTION

Size	Power	Grade	Color	Lamp Holder
6" (ø150mm)	15W	IP43	Trans- parent/ Tawny/ [Stripe]	E27
8" (ø200mm)	25W			

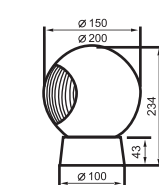

CAT No. DESCRIPTION

Size	Power	Grade	Color	Lamp Holder
6" (ø150mm)	15W	IP43	Trans- parent/ Tawny/ [Stripe]	E27

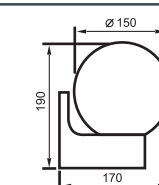

CAT No. DESCRIPTION

Size	Power	Grade	Color	Lamp Holder
6" (ø150mm)	60W	IP43	Opal	E27
8" (ø200mm)	100W			

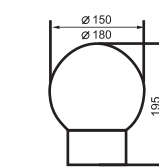

CAT No. DESCRIPTION

Size	Power	Grade	Color	Lamp Holder
6" (ø150mm)	15W	IP43	Trans- parent/ Tawny/ [Stripe]	E27

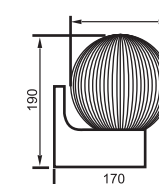

BULKHEAD

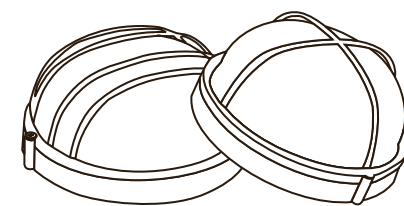

CAT No. DESCRIPTION

CAT No.	Power	Grade	Color	Lamp Holder
RR-BH09	60W	IP54	Black White Silver	E27
	100W			



CAT No. DESCRIPTION

CAT No.	Power	Grade	Color	Lamp Holder
RR-BH43	60W	IP54	Black White Silver	E27

CAT No.	Power	Grade	Color	Lamp Holder
RR-BH45	120W	IP54	Black White Silver	E27



CAT No. DESCRIPTION

CAT No.	Power	Grade	Color	Lamp Holder
RR-BH44	60W	IP54	Black White Silver	E27

CAT No.	Power	Grade	Color	Lamp Holder
RR-BH46	120W	IP54	Black White Silver	E27



CAT No. DESCRIPTION

CAT No.	Power	Grade	Color	Lamp Holder
RR-BH47	60W	IP54	Black White Silver	E27

CAT No.	Power	Grade	Color	Lamp Holder
RR-BH48	120W	IP54	Black White Silver	E27

BALLAST & ACCESSORIES

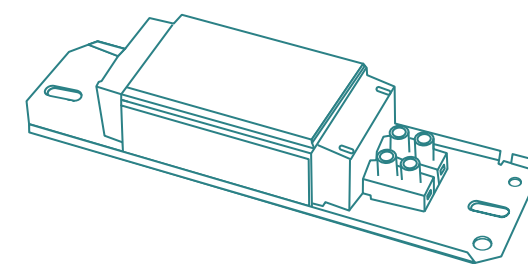

T8 MAGNETIC BALLAST



CAT No.	DESCRIPTION
RR-BL18/40	18W Fluorescent T8 Magnetic Ballast, 220V-240V 50 Hz
RR-BL36/40	36W Fluorescent T8 Magnetic Ballast, 220V-240V 50 Hz

ELECTRONIC BALLAST



CAT No.	DESCRIPTION
RR-EBL18-36	18W/36W Electronic Ballast with Wire and Clip, 220V-240V 50/60 Hz

METAL HALIDE & SODIUM BALLAST



CAT No.	DESCRIPTION
RR-MHBL70	70W Metal Halide Ballast, 220-240V 50 Hz
RR-MHBL150	150W Metal Halide Ballast, 220-240V 50 Hz
RR-MHBL250	250W Metal Halide Ballast, 220-240V 50 Hz
RR-MHBL400	400W Metal Halide Ballast, 220-240V 50 Hz
RR-HPSBL70	70W High Pressure Sodium Ballast, 220-240V 50 Hz
RR-HPSBL150	150W High Pressure Sodium Ballast, 220-240V 50 Hz
RR-HPSBL250	250W High Pressure Sodium Ballast, 220-240V 50 Hz
RR-HPSBL400	400W High Pressure Sodium Ballast, 220-240V 50 Hz

EMERGENCY KIT



CAT No.	DESCRIPTION
RR-EKIT118 / 136	1X18 / 1X36 Emergency Kit 6v2.8Ah Ni-cd battery 3 hours back up

IGNITORS



CAT No.	DESCRIPTION
RR-IGN70-400W	70-400W Aluminum Ignitor
RR-IGN70-400W-3L	70-400W Aluminum Ignitor Three Lines

CAPACITORS



CAT No.	DESCRIPTION
RR-CP-23UF	23UF Capacitor
RR-CP-28UF	28UF Capacitor

FLUORESCENT TUBES & LAMPS



FLUORESCENT TUBES



CAT No.	DESCRIPTION
RR-TLD18/54	18W T8 Fluorescent Tube Lamp 6500K
RR-TLD36/54	36W T8 Fluorescent Tube Lamp 6500K
RR-TLD18/12000K	18W T8 Fluorescent Tube Lamp 12000K
RR-TLD36/12000K	36W T8 Fluorescent Tube Lamp 12000K
RR-TL-10/20W/54	20W T10 Fluorescent Tube Lamp 6500K
RR-TL-10/40W/54	40W T10 Fluorescent Tube Lamp 6500K
RR-TLD58/54	58W T8 Fluorescent Tube Lamp 6500K

METAL HALIDE - MERCURY & SODIUM LAMP



CAT No.	DESCRIPTION
RR-MH70	70W E27 Metal Halide Lamp
RR-MH150	150W E27 Metal Halide Lamp
RR-MH250	250W E40 Metal Halide Lamp
RR-MH400	400W E40 Metal Halide Lamp
RR-MHED250W	250W E40 ED Pattern Metal Halide Lamp
RR-MHED400W	400W E40 ED Pattern Metal Halide Lamp
RR-HPS70	70W E27 Sodium Lamp
RR-HPS150	150W E27 Sodium Lamp
RR-HPS250	250W E40 Sodium Lamp
RR-HPS400	400W E40 Sodium Lamp
RR-MVL125ID	125W Mercury Vapour Lamp Indirect Type
RR-MVL250ID	250W Mercury Vapour Lamp Indirect Type

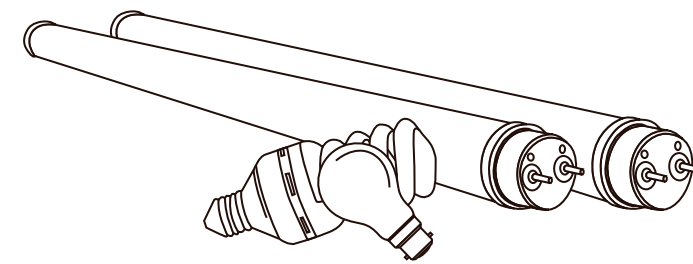

ENERGY SAVING LAMPS



CAT No.	DESCRIPTION
RR-ESE273U11W	11W Day Light E27, Energy Saving Lamp 3U
RR-ESE273U15W	15W Day Light E27, Energy Saving Lamp 3U
RR-ESE273U18W	18W Day Light E27, Energy Saving Lamp 3U
RR-ESE273U20W	20W Day Light E27, Energy Saving Lamp 3U
RR-ESE273U23W	23W Day Light E27, Energy Saving Lamp 4U
RR-ESE273U27W	27W Day Light E27, Energy Saving Lamp 4U
RR-ESE274U30W	30W Day Light E27, Energy Saving Lamp 4U
RR-ESE274U40W	40W Day Light E27, Energy Saving Lamp 4U
RR-ESE274U50W	50W Day Light E27, Energy Saving Lamp 4U
RR-ESE274U60W	60W Day Light E27, Energy Saving Lamp 4U
RR-ESE274U85W	85W Day Light E27, Energy Saving Lamp 4U
RR-ESE274U105W	105W Day Light E27, Energy Saving Lamp 4U



CAT No.	DESCRIPTION
RR-HST3B22-15W	15W B22 Day Light, Energy Saving Lamp Half Spiral T3
RR-HST3E27-15W	15W E27 Day Light, Energy Saving Lamp Half Spiral T3
RR-HST3B22-20W	20W B22 Day Light, Energy Saving Lamp Half Spiral T3
RR-HST3E27-20W	20W E27 Day Light, Energy Saving Lamp Half Spiral T3
RR-HST3E27-23W	23W E27 Day Light, Energy Saving Lamp Half Spiral T3

EMERGENCY LIGHTS

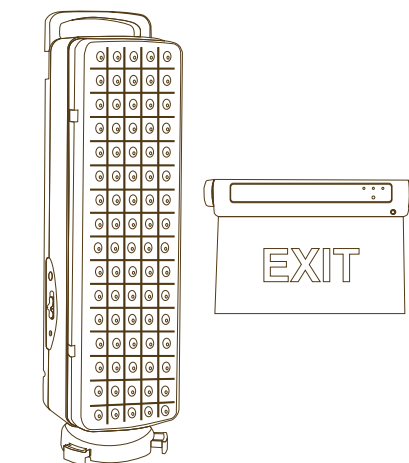

FLUORESCENT



CAT No.	DESCRIPTION
RR-502	1x8W/T5 Fluorescent Tube IP65 Voltage: 220V-240V / 50Hz / 60Hz Battery: 2.4V 4000mAh Ni-Cad Battery Operation Temperature: 0°C - 50°C Duration: 3 hours



CAT No.	DESCRIPTION
RR-1628-1	1x8W/T5 Fluorescent Tube IP40 Voltage: 220V-240V / 50Hz / 60Hz Battery: 3.6V 2500mAh Ni-Cad Battery Operation Temperature: 0°C - 50°C Duration: 3.5 hours



CAT No.	DESCRIPTION
RR-1628-2	2x8W/T5 Fluorescent Tube Ip40 Related Supply Voltage: 220V-240V / 50Hz / 60Hz Battery: 3.6V 4000mAh Ni-Cad Battery Operation Temperature: 0°C - 50°C Duration: 5 hours / 1 Tube, 3.5 hours / 2 Tubes



CAT No.	DESCRIPTION
RR-238	2x8W/T5 Fluorescent Tube Emergency and Automatic Light up Single or Double Tubes Select Wall Mounting, DC 12V Charging Function Emergency and Automatic Light up Built-in 6V 2.5Ah Sealed Lead-acid Battery



CAT No.	DESCRIPTION
RR-6508	2x20W/T8 Fluorescent Tube Emergency and Automatic Light up Single or Double Tubes Select Handle / Wall Mounting / Stand Test Function Button Built-in 6V 4Ah Sealed Lead-acid Battery



CAT No.	DESCRIPTION
RR-6405	20W/T8 Fluorescent Tube Emergency and Automatic Light up Single or Double Tubes Select Handle / Wall Mounting / Stand Test Function Button Built-in 6V 4Ah Sealed Lead-acid Battery

LED



CAT No.	DESCRIPTION
RR-6405L	60pcs Powerful LED Emergency and Automatic Light up Two way Brightness, Hi or Lo Handle / Wall Mounting / Stand Test Function Button Built-in 4V 4Ah Sealed Lead-acid Battery



CAT No.	DESCRIPTION
RR-208L	30pcs Powerful LED Test Function Button Emergency and Automatic Light up Built-in 4V 1.5Ah Sealed Lead-acid Battery



CAT No.	DESCRIPTION
RR-233L	48pcs Powerful LED Emergency and Automatic Light up Handle / Wall Mounting / Stand Test Function Button Built-in 4V 4Ah Sealed Lead-acid Battery

EXIT LIGHTS



CAT No. DESCRIPTION

RR-2912 EX Maintained, 5 pcs Super Bright LEDs
Duration: 6Hrs, Built in 3.6V 500mAh
Sealed lead -acid battery

CAT No. DESCRIPTION

RR-2912 EXRRA Maintained, 5 pcs Super Bright LEDs
Duration: 6Hrs, Built in 3.6V 500mAh
Sealed lead -acid battery

CAT No. DESCRIPTION

RR-2912 EXRLA Maintained, 5 pcs Super Bright LEDs
Duration: 6Hrs, Built in 3.6V 500mAh
Sealed lead -acid battery

CAT No. DESCRIPTION

RR-2912 EXR Maintained, 5 pcs Super Bright LEDs
Duration: 6Hrs, Built in 3.6V 500mAh
Sealed lead -acid battery

CAT No. DESCRIPTION

RR-2912 EXRRD Maintained, 5 pcs Super Bright LEDs
Duration: 6Hrs, Built in 3.6V 500mAh
Sealed lead -acid battery

CAT No. DESCRIPTION

RR-2912 EXRLD Maintained, 5 pcs Super Bright LEDs
Duration: 6Hrs, Built in 3.6V 500mAh
Sealed lead -acid battery

CAT No. DESCRIPTION

RR-2912 EXRADN Maintained, 5 pcs Super Bright LEDs
Duration: 6Hrs, Built in 3.6V 500mAh
Sealed lead -acid battery

NOTE



ACROSS THE GLOBE

Leveraging the market with unwavering passion, we are today present in 73 countries, globally. Thanks to a close knit team with exceptional skills and expertise, we strive everyday to integrate quality and innovation, better research, latest know-how, better usability and relations to provide innovative products to make life more easier and comfortable.